

# 5000.0809K1M Low Profile DATA SHEET

## GRATE OPTIONS

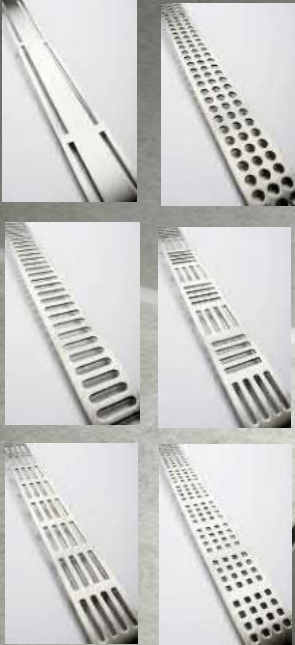

## KIT CONTAINS

UNIDRAIN GLASSLINE UNIT WITH  
INTEGRATED GLASS CHANNEL  
LOW PROFILE OUTLET  
CLASSICLINE FRAME  
ANNIVERSARIO GRATE  
GLASS SCREEN

## 5002.0810 | 5003.0810 Glassline Module

For right-aligned shower screen

For left-aligned shower screen



### ITEM NUMBER R

5002.0810

### ITEM NUMBER L

5003.0810

## Specifications

<b>MATERIAL</b>	<b>SURFACE</b>	<b>FLOORING</b>
1,5 mm stainless steel (AISI 304)	Pickled	Tiles
<b>MEMBRANE</b>	<b>FLOOR CONSTRUCTION</b>	<b>INSTALLATION WIDTH (A)</b>
Liquid or sheet membrane	Concrete/wood	801 mm
<b>INSTALLATION DEPTH (B)</b>	<b>CENTRE (C)</b>	<b>SHOWER SCREEN SIZE (D)</b>
1101 mm	401 mm	1000 mm



## 1417.0050 - Low Profile Outlet

Linear 1417.0050

Ø 50 mm horizontal drain

The odour barrier can be removed for cleaning

Can be rotated 180 degrees if a rear-facing outlet is required

Note: Odour barrier is VA-approved



### Specifications

ITEM NUMBER	GTIN NUMBER	WEIGHT INCLUDING PACKAGING
1417.0050	5707692007915	500 g
WEIGHT EXCLUDING PACKAGING	MATERIAL	USAGE
350 g	Plastic (PP)	Line drain
BARRIER	GASKET	CAPACITY
With (odour barrier)	EPDM	0.6 l/s
SIDE INLET	CENTER	FITS DRAIN UNIT
Without	30 mm	1001, 1002, 1003, 1004, 1100, 3002, 3004, 5002, 5003, 4004

FITTING HEIGHTS - LINE FAUCETS 1001, 1002, 1003, 1004

Ø	Outlet direction	300	600	700	800	900	1000	1200
Ø 50 mm	Horizontal	64 mm	68 mm	69 mm	70 mm	71 mm	72 mm	74 mm

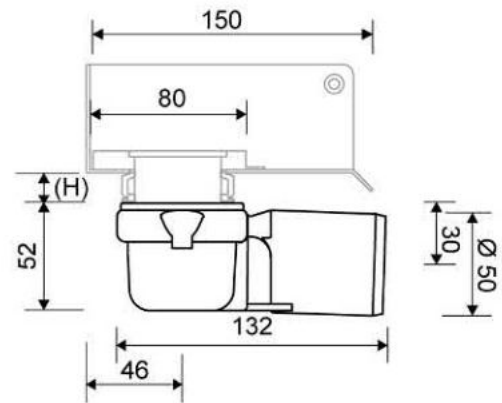
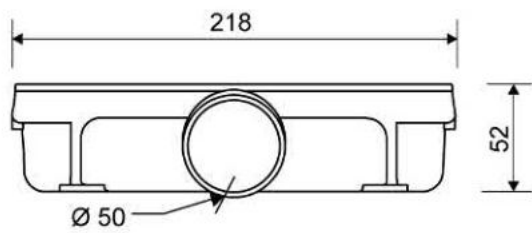
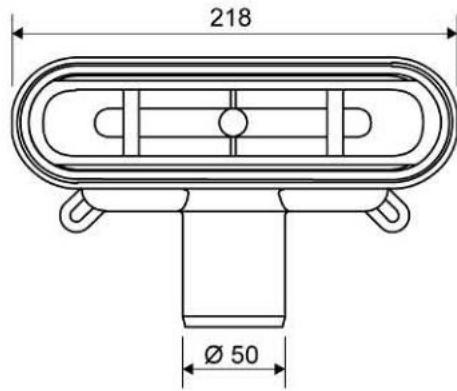

# 1500.0812

Line 1500

Available in 8, 10 and 12 mm heights (depending on the thickness of the floor tile)



## Specifications

<b>ITEM NUMBER</b>	<b>GTIN NUMBER</b>	<b>WEIGHT INCLUDING PACKAGING</b>
1500.0812	5707692003320	1010 g
<b>WEIGHT EXCLUDING PACKAGING</b>	<b>MATERIAL</b>	<b>USAGE</b>
820 g	Stainless steel (AISI 304)	Line drain
<b>SURFACE</b>	<b>INSTALLATION LENGTH (L)</b>	<b>HEIGHT (H)</b>
Brushed	795 mm	H 12 mm
<b>LENGTH MODEL</b>	<b>FITS DRAIN UNIT</b>	<b>INSERT</b>
800 mm	1001, 1002, 1003, 1004, 1100, 5002, 5003	Synthetic

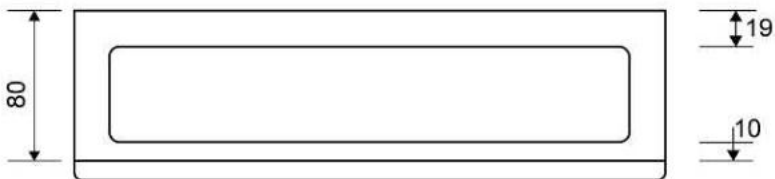
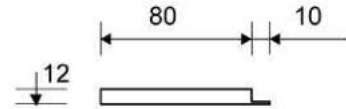
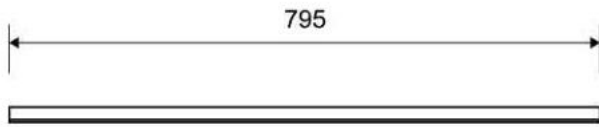

**1500.0812**

# 1606.0800 - 800mm Anniversario Grate

Line 1600

Brushed Stainless Steel grate to be placed onto Classicline Frame

Contact Wet Room Materials for other grate options

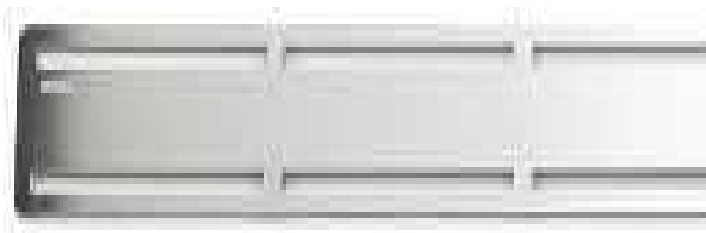

Other grates available

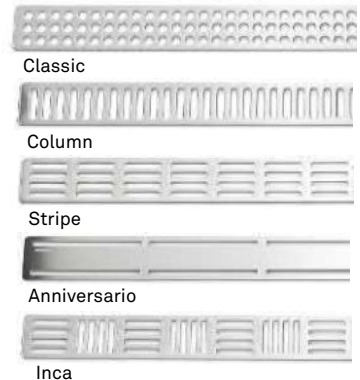

## Specifications

ITEM NUMBER	GTIN NUMBER	WEIGHT INCLUDING PACKAGING
1604.0800	5707692001197	730 g
WEIGHT EXCLUDING PACKAGING	MATERIAL	USAGE
700 g	Stainless steel (AISI 304)	Line drain
SURFACE	LENGTH MODEL	DIMENSIONS
Brushed	800 mm	3 mm solid3 mm solid3 mm solid3 mm solid3 mm solid3 mm solid



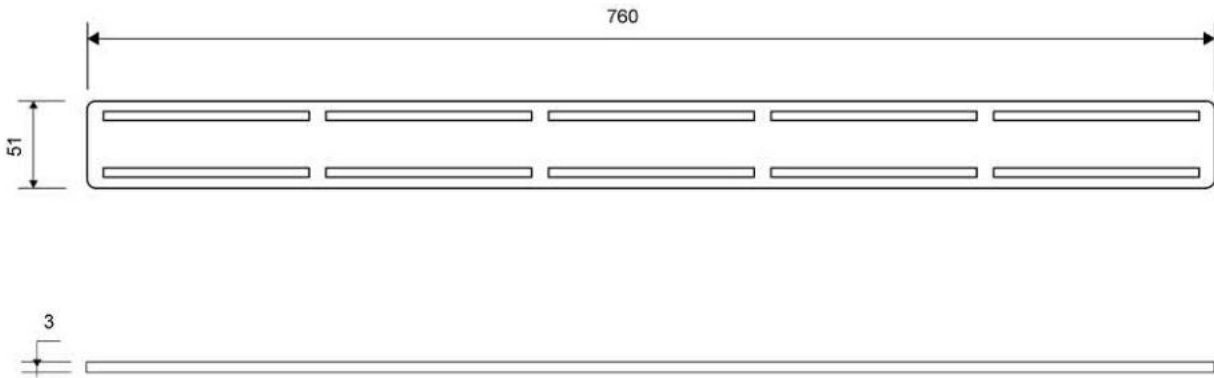

**1606.0800**

Products

## 5100.1000

GlassLine | Right and left-aligned shower screen

Design: Transparent

10 mm safety glass

No visible screws or fittings in the finished result

The glass surface is treated with Cleantec nanotechnology, making it water-repellent, less susceptible to limescale and easier to clean.



### Specifications

<b>ITEM NUMBER</b>	<b>LENGTH MODEL</b>	<b>HEIGHT (H)</b>
5100.1000	1000 mm	2104 mm
<b>DESIGN</b>	<b>MATERIAL</b>	
Transparent	Stainless steel (AISI 304) 10 mm safety float glass	

